

TRACK DALI



TRACK DALI

- Stromschienensystem für Aufbau- und Pendelmontage mit Datenbus
- Profil aus stranggepresstem Aluminium
- 3 Standard Profilfarben
- 4 Kupferleiter (2,5 mm²) in Kunststoffbahnen eingebettet
+ zwei Datenleiter (DALI, DMX, 0-10 V, KNX)
- Vorgestanzte Befestigungslöcher
- Längenanpassung durch Absägen möglich
- 220-240 V max. 3 x 16 A

Farben für Stromschienen (standardmäßig beschichtet)

- Weiß ähnlich RAL 9016
- Schwarz ähnlich RAL 9005
- Silber ist eloxiert E6/EV1

Farben für Systemteile und Adaptern

- Weiß ähnlich RAL 9016
- Schwarz ähnlich RAL 9005
- Grau ähnlich RAL 7038
- Silber lackiert ähnlich RAL 9006

- Zubehör ab Seite 30
- Planungsschema Seite 31

- For ceiling mounted or pendant installation with data bus
- Extruded aluminium profile
- 3 standard profile colours
- 4 copper conductors (2,5 mm²) embedded in plastics
+ two data conductors (DALI, DMX, 0-10 V, KNX)
- Pre-punched mounting holes for installation
- Adaption of length by sawing
- 220-240 V max. 3 x 16 A

Colours for power tracks (standard coated)

- White, similar to RAL 9016
- Black, similar to RAL 9005
- Silver, is anodized E6/EV1

Colours for system components and adaptors

- White, similar to RAL 9016
- Black, similar to RAL 9005
- Grey, similar to RAL 7038
- Varnished in silver, similar to RAL 9006

- Accessories see page 30
- Planning scheme see page 31



Deckenmontage
Ceiling mounting



Pendelmontage
Pendant mounting

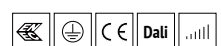

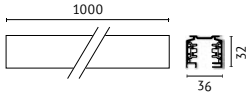
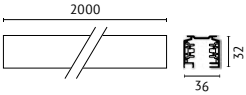
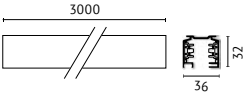
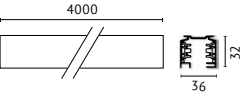
				
Farbe Colour	1000 mm Länge Length	2000 mm Länge Length	3000 mm Länge Length	4000 mm Länge Length
Weiß White	225-101N	225-201N	225-301N	225-401N
Schwarz Black	225-102	225-202	225-302	225-402
Silber Silver	225-103	225-203	225-303	225-403

Zubehör | Accessories

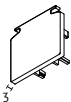
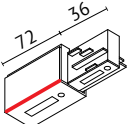
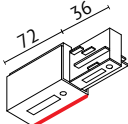
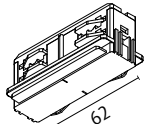
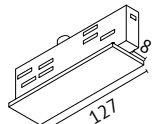
					
	Endkappe End-cap	DALI Einspeiser End-feed	DALI Einspeiser End-feed	DALI Elektrischer Längsverbinder Electrical straight connector	DALI Mitteneinspeiser Mid-feed
Farbe Colour		<ul style="list-style-type: none"> Mit Datenbus Schutzleiter rechts With data bus Ground right 	<ul style="list-style-type: none"> Mit Datenbus Schutzleiter links With data bus Ground left 	<ul style="list-style-type: none"> Mit Datenbus Innenliegend, bei Seil- und Pendelaufhängung aus statischen Gründen Stoßstellenverbinder separat bestellen With data bus To join two sections of track electrically. For static reasons order mechanical coupler if suspended via pendant rod or wire 	<ul style="list-style-type: none"> Mit Datenbus Für bauseitige Profilbohrung An beliebiger Stelle ohne Teilung der Stromschiene positionierbar With data bus For on-site profile drilling To be placed anywhere along the track; track cutting not required
Weiß White	SCH-012171N	555212011N	555212021N	555212061N	555252031N
Schwarz Black	SCH-012172	555212012	555212022	555212062	555252032
Silber Silver	SCH-012177	555212017	555212027	555212067	555252037

Verbinder mit Einspeisemöglichkeit | Connector with feeding option

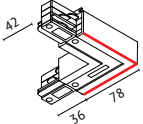
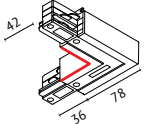
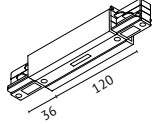
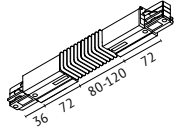
				
	DALI Eckverbinder L-connector	DALI Eckverbinder L-connector	DALI Längsverbinder Straight connector	DALI Flexverbinder Flexible connector
Farbe Colour	<ul style="list-style-type: none"> Mit Datenbus Schutzleiter außen With data bus Ground outside 	<ul style="list-style-type: none"> Mit Datenbus Schutzleiter innen With data bus Ground inside 	<ul style="list-style-type: none"> Mit Datenbus With data bus 	<ul style="list-style-type: none"> Mit Datenbus Biegeradius von 30° bis 330° With data bus 30° to 330° bending radius
Weiß White	555212091N	555212101N	555212081N	555212111N
Schwarz Black	555212092	555212102	555212082	555212112
Silber Silver	555212097	555212107	555212087	555212118 Grau Grey

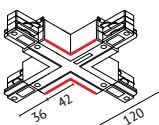
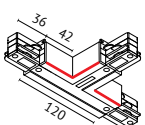
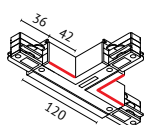
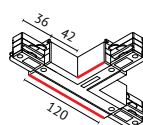
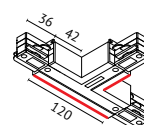

Verbinder mit Einspeisemöglichkeit | Connector with feeding option

					
	X-Verbinder X-connector	T-Verbinder T-connector	T-Verbinder T-connector	T-Verbinder T-connector	T-Verbinder T-connector
Farbe Colour	<ul style="list-style-type: none"> Mit Datenbus With data bus 	<ul style="list-style-type: none"> Mit Datenbus Schutzleiter innen, rechts With data bus Ground inside, right 	<ul style="list-style-type: none"> Mit Datenbus Schutzleiter innen, links With data bus Ground inside, left 	<ul style="list-style-type: none"> Mit Datenbus Schutzleiter außen, rechts With data bus Ground outside, right 	<ul style="list-style-type: none"> Mit Datenbus Schutzleiter außen, links With data bus Ground outside, left
Weiß White	555212161N	555212121N	555212131N	555212141N	555212151N
Schwarz Black	555212162	555212122	555212132	555212142	555212152
Silber Silver	555212167	555212127	555212137	555212147	555212157



ZUBEHÖR

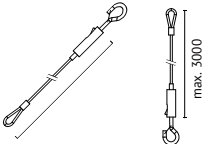

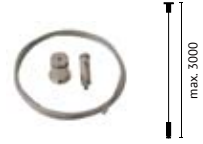
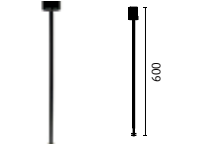
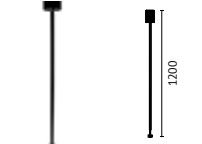
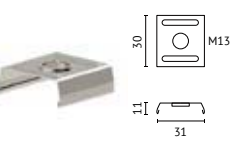
Zubehör | Accessories

					
Seil mit Schnellabhänger Steel wire with fast hanger	Stahseilauflhängung Steel cord suspension	Standard-Seilauflhängung Standard steel suspension	Rohrpendelaufhängung Pendant rod	Rohrpendelaufhängung Pendant rod	Stromschienen Clip Power track clip
<ul style="list-style-type: none"> Für Halteclip, höhenverstellbar Länge 3000 mm Fastening clip, height-adjustable Length 3000 mm 	<ul style="list-style-type: none"> Zu verwenden mit Pendelclip oder Stoßstellenverbinder Höhenverstellbar, verzinkt To be used with pendant clip or mechanical coupler Height adjustable, galvanized 	<ul style="list-style-type: none"> Für vorhandene Profilbohrungen (keine Befestigungsklammer notwendig), höhenverstellbar, vernickelt Mindestens 2 Stk. notwendig Suspension no add clips needed, height adjustable, nickel-plated Minimum 2 pieces necessary 	<ul style="list-style-type: none"> Zu verwenden mit Pendelclip oder Stoßstellenverbinder Höhenverstellbar, verzinkt To be used with pendant clip or mechanical coupler Height adjustable, galvanized 	<ul style="list-style-type: none"> Zu verwenden mit Pendelclip oder Stoßstellenverbinder Höhenverstellbar, verzinkt To be used with pendant clip or mechanical coupler Height adjustable, galvanized 	<ul style="list-style-type: none"> Für Rohrpendelaufhängung für Ø13 mm For tube pendant rod for Ø13 mm
Silber Silver	Silber Silver	Silber Silver	Weiß White	Weiß White	Weiß White
SCH-6790	SCH-3187	SCH-6410	SCH-9051N	SCH-9061N	SCH-M131N
	1500 mm Länge Length	1500 mm Länge Length	Schwarz Black	Schwarz Black	Schwarz Black
	SCH-3197	SCH-6430	SCH-9052	SCH-9062	SCH-M132
	3000 mm Länge Length	3000 mm Länge Length	Silber Silver	Silber Silver	Silber Silver
	SCH-6207			SCH-9067	SCH-M137
	6200 mm Länge Length				

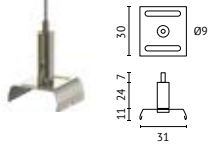
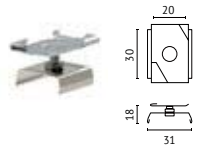
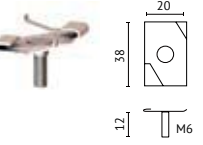
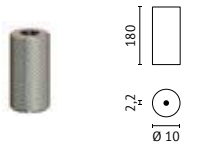
Zubehör | Accessories



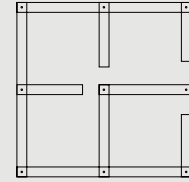
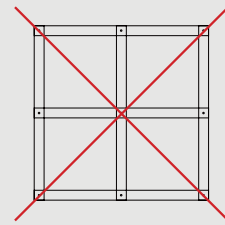
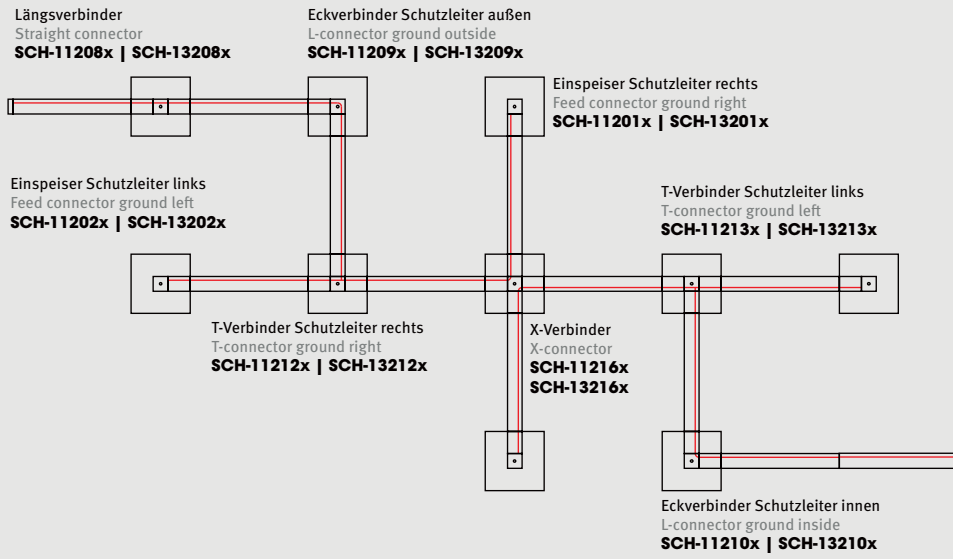

					
Gripper mit Stromschienenclip Gripper with clip	Deckenclip Clip for ceiling grid	Deckenclip Clip for ceiling grid	Kappe für Deckenclip Cap for ceiling grid clip	Monopoint Monopoint	Einbautopf für Monopoint Fitting pot for monopoint
<ul style="list-style-type: none"> Passend für Eutrac Stromschienen Max. Seil Ø1,5 mm Suitable for Eutrac-power-track Max. suspension Ø1,5 mm 	<ul style="list-style-type: none"> Deckenclip für Rasterdecken mit Klammer Clip for ceiling grid with fastener 	<ul style="list-style-type: none"> Deckenclip M6 für Rasterdecken Clip M6 for ceiling grid 	<ul style="list-style-type: none"> Kappe M6 mit Rändelung Bohrung 2,2 mm Cap M6 with curl Hole 2,2 mm 	<ul style="list-style-type: none"> Aufbau-Universal-Punktauslaß für 3-Phasen-Adapter Mit Datenbus-Kontakt Bis 10 kg belastbar Surface-mounted universal 3-phase-adaptor Data bus contact Max. load up to 10 kg 	<ul style="list-style-type: none"> Ausgelegt für Deckenstärken bis 30 mm Mindesteinbauhöhe 75 mm Bis 10 kg belastbar Designed for ceiling panels up to 30 mm thickness Minimal installation height 75 mm Max. load up to 10 kg
Weiß White	Silber Silver	Verzinkt Galvanized	Silber Silver	Weiß White	Weiß White
SCH-1511N	SCH-001KLN	SCH-001N	SCH-008	SCH-072281N	SCH-072271N
Schwarz Black				Schwarz Black	Schwarz Black
SCH-1512				SCH-072282	SCH-072272
Silber Silver				Silber Silver	Silber Silver
SCH-1517				SCH-072287	SCH-072277





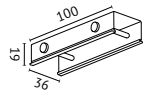

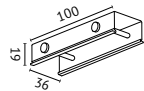
Ein störungsfreier Datenbusbetrieb ist nur gewährleistet, wenn keine Ringschlussstrukturen erzeugt werden.

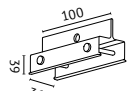
An undisturbed data bus operation is only ensured if no ring closure structure is produced.

Zubehör | Accessories

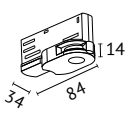
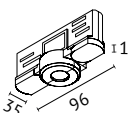
											
Pendelclip Pendant clip	Stoßstellenverbinder Mechanical coupler	Pendelclip Pendant clip	Stoßstellenverbinder Mechanical coupler	Pendelclip Pendant clip	Stoßstellenhalteclip Mechanical coupler						
<ul style="list-style-type: none"> • Notwendiges Zubehör für Rohr- und Seilpendel • Necessary accessories for steel cable or pendant mounting 			<ul style="list-style-type: none"> • Für Abhängung mit Schnellabhänger oder Ketten, Stahlblech verzinkt • For suspension with fast hanger or chain, galvanized steel 								
Weiß White	SCH-0751N	Weiß White	SCH-1231N	Verzinkt Galvanized	SCH-6980	Verzinkt Galvanized	SCH-6990	Verzinkt Galvanized	SCH-6970	Verzinkt Galvanized	SCH-6720
Schwarz Black	SCH-0752	Schwarz Black	SCH-1232								
Silber Silver	SCH-0757	Silber Silver	SCH-1237								

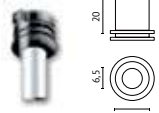
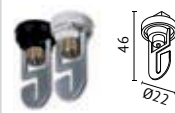
Zubehör | Accessories

											
LA-40 UniCompact Adapter mit Datenbus-Option LA-40 universal adapter with data bus option	LA-50 UniCompact Adapter LA-50 universal adapter	Montagenippel für LA-50 Bügelmontage Retaining collar for LA-50 mounting bracket	Steckdosen-Multi-Adapter Power-socket adapter	Mechanischer Universalhaken Mechanical universal hook	Kappe für Universalhaken Mechanical universal hook						
<ul style="list-style-type: none"> • Zur Befestigung von Strahlern und Leuchten oder zur Ausspeisung • Inkl. 2 Montagenippel für Pendelmontage M10x1 u. Bügelmontage M10x1 und 2 Patentschieber • To fix spotlights and luminaires • Incl. 2 different retaining collars (for pendant rod M10x1 and for bracket M10x1) and 2 smart sliders 	<ul style="list-style-type: none"> • Zur Befestigung von Strahlern und Leuchten oder zur Ausspeisung • Verwendung in Verbindung mit diversen Montagenippeln • Polycarbonat • To fix spotlights and luminaires • To be used with different retaining collars • Polycarbonate 	<ul style="list-style-type: none"> • Für Schnurpendel • For pendant band 	<ul style="list-style-type: none"> • Für Pendelrohr • For pendant rod 	<ul style="list-style-type: none"> • Steckdosen-Multi-Adapter • Sicherung, 6,3A träge • Power-socket adapter • With idle 6,3A time-lag fuse 	<ul style="list-style-type: none"> • Mechanischer Universalhaken • Z.B. zum Einhängen von Werbeschilddern oder Leuchten • bis 10 kg belastbar • Mechanical universal hook • E.g. to suspend advertisement signs or luminaires • Max. load up to 10 kg 						
Weiß White	LA-40	Weiß White	SCH-0831N	Weiß White	SCH-0841N	Weiß White	SCH-0951N	Weiß White	SCH-0671N	Weiß White	SCH-2841N
Schwarz Black	LA-40SW	Schwarz Black	SCH-0832	Schwarz Black	SCH-0842	Schwarz Black	SCH-0952	Schwarz Black	SCH-0672	Schwarz Black	SCH-2842
		Silber Silver	SCH-0837	Silber Silver	SCH-0847					Silber Silver	SCH-2847