



KNX Universal Actuator

KAA-8R



■ Features

- 8 channel actuator in a compact size
- Suitable for various and mixed applications
- For AX, C-load, capacitive & inductive of loads
- Program via ETS5.0 software
- Manual control via Push button
- Programmable various time and scene function
- 3 years warranty

■ Applications

- Building Automation
- Lighting switch
- Shutter/Blind control(Planned)
- Heating control
- Ventilation function

■ Description

The KNX actuator is a 8 channel device with high quality independent latching relay for switch, shutter or any possible mixed applications. The compact design with 4 units (72 mm) wide modular makes it suitable for installation in the distribution board on 35 mm mounting rails in the EIB / KNX application. The connection to the KNX bus is implemented via a bus connection terminal. The switching relays are particularly suitable for switching ohmic loads, capacitive loads, for instance LED drivers and inductive loads as well as motors in shutter or blind applications. The actuator are powered via the EIB / KNX and do not require any additional power supply.

■ Model Encoding

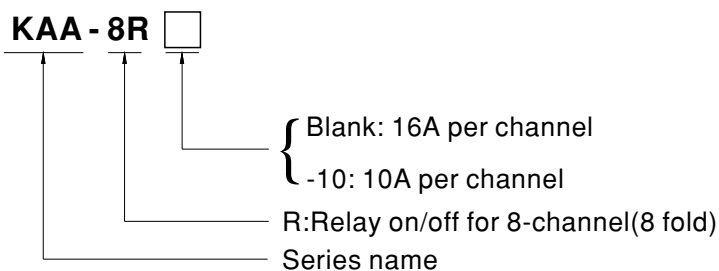

Type	Function	Note
Blank	8 channel actuator, 16A per channel	In stock
-10	8 channel actuator, 10A per channel	In stock



SPECIFICATION

MODEL		KAA-8R	KAA-8R-10	
SUPPLY	KNX BUS VOLTAGE	21~31V		
	CURRENT CONSUMPTION	<6mA		
	POWER CONSUMPTION	<180mW		
	Nr. OF SWITCHING OUTPUT	8		
	Nr. OF SHUTTER OUTPUT	4(Planned)		
	OUTPUT TYPE	Independent, potential-free bistable(latching) relay		
OUTPUT SWITCHING RATINGS	VOLTAGE	230VAC@50Hz		
	CURRENT	OHMIC LOAD	16A	10A
		CAPACITIVE LOAD	220 μ F(See Note.2)	220 μ F(See Note.2)
	MAX. INRUSH CURRENT	800A(max. 200 μ s),165A(max. 20ms)		
	EN60947-4-1 AC1(COS θ =0.8)	16A	10A	
	EN60947-4-1 AC3(COS θ =0.45)	8A	5A	
	EN60947-4-1 AC5a(COS θ =0.45)	8A	8A	
	EN60947-4-1 AC5b	16A	10A	
MAX. TOTAL CURRENT OF THE ACTUATOR	80A	56A		
OUTPUT SERVICE LIFE	MECHANICAL SERVICE LIFE	>10 ⁶		
	ELECTRICAL ENDURANCE EN60669-1 19.1	10 ⁴ (See Note.2)	4*10 ⁴ (See Note.2)	
	EN60669-1 19.2 , FLOURSCENT LAMP(AX)	10 ⁴ (See Note.2)	10 ⁴ (See Note.2)	
OPERATING & DISPLAY	PROGRAMMING BUTTON/LED	Program the individual address		
	MANUAL BUTTON/LED	Manual control and indication		
ENVIRONMENT	WORKING TEMP.	-30 ~ +45°C (3K5)		
	STORAGE TEMP.	-35 ~ +70°C		
	WORKING HUMIDITY	10 ~ 95% RH non-condensing		
	PROTECTION CLASS	II , According to EN61140		
	OVER VOLTAGE CATEGORY	III , According to EN60664-1		
	POLLUTION DEGREE	2, According to EN60664-1		
	DEGREE OF PROTECTION	IP20,According to EN60529		
SAFETY & EMC	SAFETY STANDARDS	EN50491-3, EN60669-1, EN60669-2-1, EN60669-2-5(See Note.2)		
	EMC EMISSION	Compliance to EN50491-5-1,-2,-3, EN50090-2-2, EN60669-2-1, EN60669-2-5, EN63044-5-1,-2,-3(See Note.2)		
	EMC IMMUNITY	Compliance to EN50491-5-1,-2,-3, EN50090-2-2, EN60669-2-1, EN60669-2-5, EN63044-5-1,-2,-3(See Note.2)		
CONNECTIONS	SCREW TERMINAL	0.5 – 4.0mm ² solid core 0.5 - 2.5mm ² finely stranded		
	KNX BUS CONNECTION TERMINAL	0.8mm ϕ , solid core		
OTHERS	DIMENSION	72*90*57mm (W*H*D)		
	MOUNTING WIDTH IN UNITS	4		
	DIN RAIL MOUNTING	35mm mounting rail according to DIN EN60715		
	PACKING	0.312Kg ; 48pcs/16Kg/1.02CUFT		
NOTE	1. All parameters NOT specially mentioned are measured at 230VAC input, rated load and 25°C of ambient temperature. 2. Notified Body test report is provided.			



■ Block Diagram

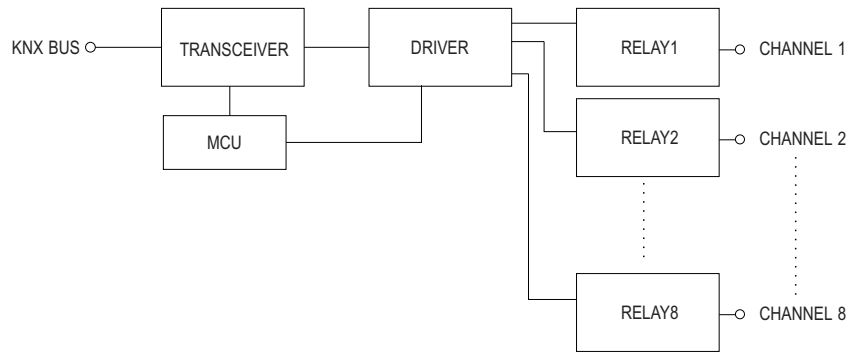

■ Mechanical Specification

Case No. KAA

Unit:mm

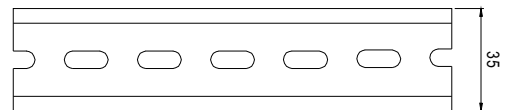
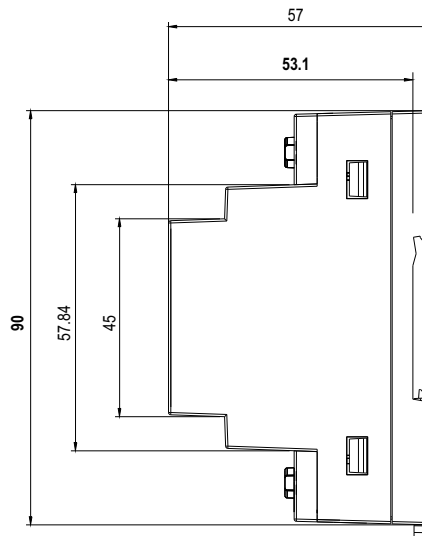
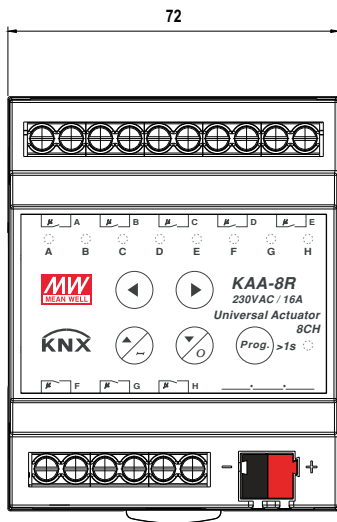

ADMISSIBLE DIN-RAIL: TS35/7.5 OR TS35/15



■ Max. output load per channel

Maximum load	KAA-8R	KAA-8R-10
Resistive load or heater	3680W	2300W
LED driver	refer to table below	refer to table below
Incandescent lamps	2300W	2300W
Halogen lamps 230V	2300W	2300W
Halogen lamps, electronic transformer	1300W	1300W
Fluorescent lamps, not compensated	2000W	2000W
Fluorescent lamps, parallel comp.	1200W	1200W
Max. number of electronic transformers	15	15
Shutter motor	600W	600W

■ Nr. of driver per channel

The maximum number of the MEANWELL LED driver that can be connected to each channel at 230V is shown as below		
Suggested model	KAA-8R	KAA-8R-10
APC-8	22	22
APC-12	11	11
APC-16	18	18
APC-25	11	11
APC-35	11	11
APC-8E	22	22
APC-12E	18	18
APC-16E	15	15
APV-8	22	22
APV-12	11	11
APV-16	18	18
APV-25	11	11
APV-35	11	11
APV-8E	22	22
APV-12E	18	18
APV-16E	15	15
LCM-25	25	25
LCM-40	25	25
LCM-60	25	25
LCM-25DA	25	25
LCM-40DA	25	25
LCM-60DA	25	25
LPC-20	11	11
LPC-35	9	9
LPC-60	8	8
LPC-100	7	7
LPC-150	13	5



The maximum number of the MEANWELL LED driver that can be connected to each channel at 230V is shown as below		
Suggested model	KAA-8R	KAA-8R-10
LPF-16	18	18
LPF-25	16	16
LPF-40	16	16
LPF-60	9	9
LPF-90	7	7
LPF-16D	18	18
LPF-25D	16	16
LPF-40D	16	16
LPF-60D	9	9
LPF-90D	7	7
LPH-18	16	16
LPHC-18	16	16
LPV-20	11	11
LPV-35	9	9
LPV-60	8	8
LPV-100	7	7
LPV-150	8	8
NPF-40	10	10
NPF-60	10	10
NPF-90	8	8
NPF-120	8	8
NPF-40D	10	10
NPF-60D	10	10
NPF-90D	8	8
NPF-120D	8	8
PCD-16B	80	80
PCD-25B	53	53
PCD-40B	45	45
PCD-60B	26	26
PLC-30	23	23
PLC-45	23	23
PLC-60	23	23
PLC-100	13	13
PLD-16B	40	40
PLD-25	32	32
PLD-40B	32	32
PLD-60B	32	32
PLM-12	53	53
PLM-25	53	53
PLM-40	53	53
PLN-20	23	23
PLN-30	23	23
PLN-45	23	23
PLN-60	23	23
PLN-100	13	13
PLP-30	32	32
PLP-45	27	27
PLP-60	23	23
PWM-40	10	10
PWM-60	10	10
PWM-90	8	8
PWM-120	8	8



The maximum number of the MEANWELL LED driver that can be connected to each channel at 230V is shown as below		
Suggested model	KAA-8R	KAA-8R-10
HLN-40H	10	10
HLN-60H	9	9
HLN-80H	7	7
HLP-40H	7	7
HLP-60H	9	9
HLP-80H	7	7
CEN-60	22	22
CEN-75	22	22
CEN-100	22	22
CLG-60	23	23
CLG-100	13	13
CLG-150	8	8
ELG-75	10	10
ELG-100	8	8
ELG-150	8	8
ELG-75-C	10	10
ELG-100-C	13	13
ELG-150-C	8	8
HBG-100	8	8
HBG-160	8	8
HBG-240	7	7
HBG-60	18	18
HLG-40H	16	16
HLG-60H	9	9
HLG-80H	7	7
HLG-100H	8	8
HLG-120H	8	8
HLG-150H	8	8
HLG-185H	8	8
HLG-240H	7	5
HLG-320H	7	6
HLG-600H	4	3
HLG-60H-C	8	8
HLG-80H-C	8	8
HLG-120H-C	10	10
HLG-185H-C	9	9
HLG-240H-C	7	7
HLG-320H-C	7	6
HSG-70	9	9
HVG-65	20	20
HVG-100	8	8
HVG-150	8	8
HVG-240	5	5
HVG-320	4	4
HVGC-65	20	20
HVGC-100	8	8
HVGC-150	8	8
HVGC-240	5	5
HVGC-320	4	4

■ Configuration and Commissioning

The application program(database) can be downloaded via Online Catalogs from ETS or via <http://www.meanwell.com/productCatalog.aspx>

■ Typical application

⊙ Application 1: Work with non-dimmable driver

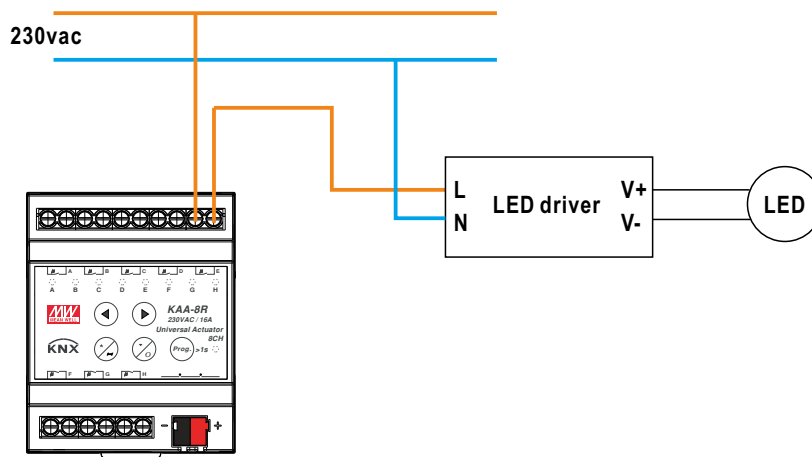

⊙ Application 2: Work with Heater

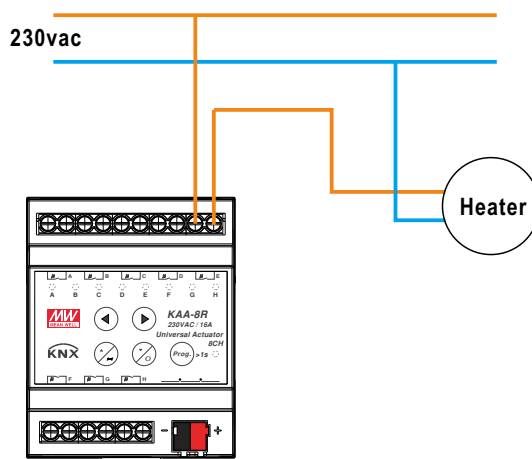

■ Recommended Screwdriver, Wire and Torque Setting

1. Screwdriver(Width*Thick): Slotted screwdriver 2.5*0.4~3.5*0.6
2. Wire: 0.5~4.0mm² solid core or 0.5~2.5mm² finely stranded
3. Torque: 0.8Nm

■ Installation Manual

Please refer to : <http://www.meanwell.com/manual.html>