

FEATURES

- Bartenbach 'Dark Light' technology
- Low UGR levels combined with high light output

Bartenbach^B
lighting optics



SPRINGS

Standard with CS spring (concrete/gyproc). Also available as above with WS spring (gyproc/metal).



COLOURS

Available colours:

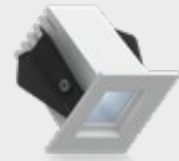

Matt white RAL 9016 (XX=MW)
Matt grey RAL 9006 (XX=GR)
Matt black RAL 9005 (XX=BL)

Fabio 35

Fixed

SPECIFICATIONS

Beam angle (FWHM)	40° (65° FWTM)
Fixture material	Housing: Die cast aluminium / Reflector glass: Polycarbonate
Environment	Indoor
IK rate	IK03
Operating temperature (Ta)	-20°C / +45°C
Safety marks	EN60598 / EN62031 / EN62471
EMC compliance	EN55015
Colour consistency (SDCM)	MacAdam step 3
Warranty	7 years * (within the European Union and the countries of the Free Trade Association for products delivered after 1 May 2015)
Energy class	A

This luminaire contains built-in LED lamps. There are no exchangeable parts inside the luminaire. EU 874/2012



Only when the product is installed in a closed ceiling it may be exposed to water splashes, and only on its front side.

IP20

IP44

FABIO 35 VARIATIONS

Fabio 35 LV	100-240V	incl. power supply	page 3
Fabio 35 LV-C	350mA	to be connected to a central power supply	page 4
Fabio 35 LV-X	24Vdc	to be connected to a central power supply	page 5

DIMENSIONS

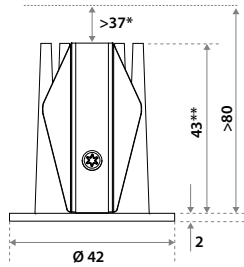

- * This distance is necessary because of the height of the connection box (80 mm). For purely heat reasons just 5 mm is sufficient.
- ** For WS springs this dimension is 60 mm

HOLE SIZE



Using CS (concrete) springs (concrete/gyproc)

For 5-80 mm ceiling thickness.
Recess depth 80 mm (incl. 5mm space for air ventilation).



Using WS (wire) springs (gyproc/metal)

For 1-50 mm ceiling thickness.
Recess depth 80 mm (incl. 5mm space for air ventilation).

FABIO 35 (non-dimmable - incl. individual power supply)

100-240V

Downlight incl. PSU

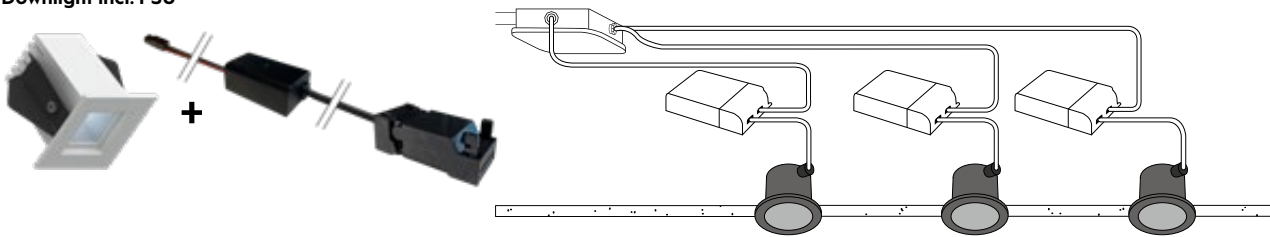

ITEM SPECIFICATIONS (PART A)

Description	Item code CS	Item code WS	Input	W	Lm	Lm/W	CRI (typ.)	UGR	Pf	Ripple	Inrush current	B-16A Fuse
Fabio 35 LV 375 Lm 2700K No dim	965303XX6513	965303XX6813	100-240V	5,7	375	66	82	10.7	0.6	<3%	20A 170µS	50 pcs
Fabio 35 LV 400 Lm 3000K No dim	965303XX6613	965303XX6913	100-240V	5,7	400	70	82	10.9	0.6	<3%	20A 170µS	50 pcs
Fabio 35 LV 425 Lm 4000K No dim	965303XX6713	965303XX7013	100-240V	5,7	425	75	82	11.1	0.6	<3%	20A 170µS	50 pcs

ITEM SPECIFICATIONS (PART B)

Description	Safety class	Energy class	Weight	Dimensions single carton	Quantity per pallet	Expected lifespan (25°C)		
						L70B50	L80B50	L90B50
Fabio 35 LV	II	A	172 gr	105x105x61 mm	42 pcs	259.260 hrs	156.636 hrs	65.836 hrs

All values are measured at 230V (+/- 7%)

INCL. PSU NO DIM

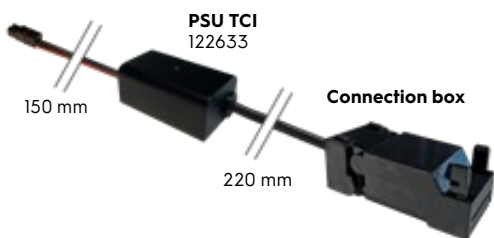

FABIO 35 (dimmmable - excl. central power supply)

350 mA

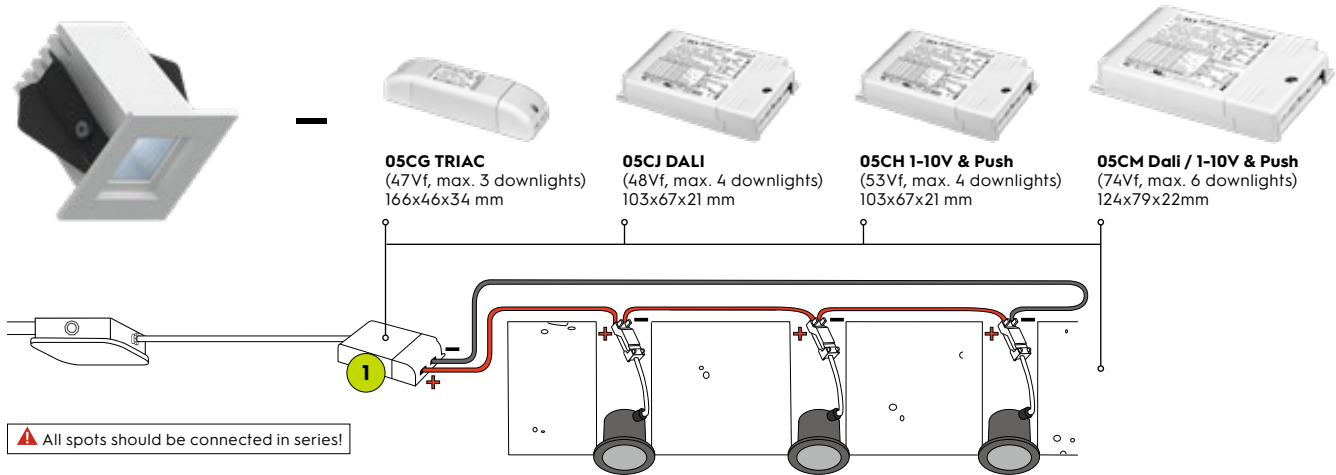

ITEM SPECIFICATIONS (PART A)

Description	Item code CS	Item code WS	Input	Vf	W	Lm	Lm/W	CRI (typ.)	UGR	Pf	Ripple	Inrush current	B-16A Fuse
Fabio 35 LV-C 350mA 375 Lm 2700K Dim	965303XX0111	965303XX1A11	350mA	11,9	4,5	375	83	82	10.7	x	x	x	x
Fabio 35 LV-C 350mA 400 Lm 3000K Dim	965303XX7211	965303XX2A11	350mA	11,9	4,5	400	89	82	10.9	x	x	x	x
Fabio 35 LV-C 350mA 425 Lm 4000K Dim	965303XX0211	965303XX3A11	350mA	11,9	4,5	425	94	82	11.1	x	x	x	x

ITEM SPECIFICATIONS (PART B)

Description	Safety class	Energy class	Weight	Dimensions single carton	Quantity per pallet	Expected lifespan (25°C)		
						L70B50	L80B50	L90B50
Fabio 35 LV-C 350mA	III	A	122 gr	105x105x61 mm	42 pcs	259.260 hrs	156.636 hrs	65.836 hrs

ITEM SPECIFICATIONS (PART A)

Description	Item code	Input	Watt	Current	Efficiency	Pf	Ripple	Weight	Inrush current	B-16A Fuse
PSU 32W 350mA Triac (1)	05CG03MLMD00	220-240V	32W (47Vf)	350mA	85%	0.97	<3%	138 gr	5A 50µS	50 pcs
PSU 32W 350mA Dali (1)	05CJ03MLMD00	220-240V	32W (48Vf)	350mA	87%	0.98	<3%	138 gr	5A 50µS	50 pcs
PSU 32W 350mA 1-10V & Push (1)	05CH03MLMD00	220-240V	32W (53Vf)	350mA	90%	0.95	<3%	138 gr	5A 50µS	50 pcs
PSU 50W 350mA Dali / 1-10V & Push (1)	05CM03MLMD00	220-240V	50W (74Vf)	350mA	89%	0.95	<3%	218 gr	20A 400µS	50 pcs

All values are measured at 230V (+/- 7%)

INCLUDING CONNECTION BOX

For installation to a central power supply.

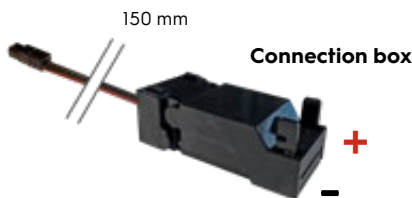

FABIO 35 (non-dimmable - excl. central power supply)

24Vdc

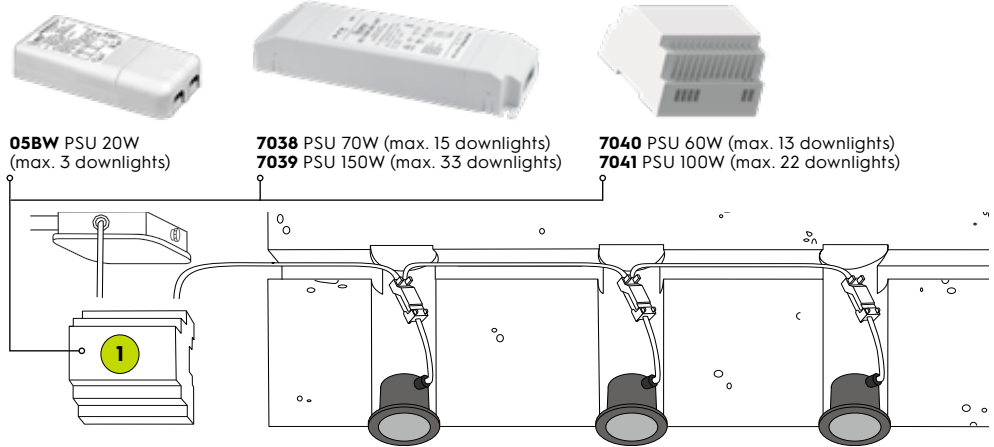

Easy installation, all spots can be connected in parallel!

ITEM SPECIFICATIONS (PART A)

Description	Item code CS	Item code WS	Input	W	Lm	Lm/W	CRI (typ.)	UGR	Pf	Ripple	Inrush current	B-16A Fuse
Fabio 35 LV-X 24Vdc 375 Lm 2700K No dim	961903XX0111	961903XX1A11	24Vdc	4,5	375	83	82	10.7	x	x	x	x
Fabio 35 LV-X 24Vdc 400 Lm 3000K No dim	961903XX7211	961903XX2A11	24Vdc	4,5	400	89	82	10.9	x	x	x	x
Fabio 35 LV-X 24Vdc 425 Lm 4000K No dim	961903XX0211	961903XX3A11	24Vdc	4,5	425	94	82	11.1	x	x	x	x

ITEM SPECIFICATIONS (PART B)

Description	Safety class	Energy class	Weight	Dimensions single carton	Quantity per pallet	Expected lifespan (25°C)		
						L70B50	L80B50	L90B50
Fabio 35 LV-X 24Vdc	III	A	122 gr	105x105x61 mm	42 pcs	259.260 hrs	156.636 hrs	65.836 hrs

ITEM SPECIFICATIONS (PART A)

Description	Item code	Input	Watt	Efficiency	Pf	Ripple	Dimensions	Weight	Inrush current	B-16A Fuse
PSU 20W 24Vdc No dim (1)	05BW03MLMC00	220-240V	20W	87%	0.93	<3%	111x52x22 mm	108 gr	5A 50µs	50 pcs
PSU 70W 24Vdc No dim (1)	703805000002	220-240V	70W	91%	0.97	<3%	225x60x36 mm	448 gr	15A 600µs	15 pcs
PSU 150W 24Vdc No dim (1)	703905000002	220-240V	150W	94%	0.98	<3%	240x60x49 mm	582 gr	35A 1000µs	8 pcs
PSU DIN RAIL 60W 24Vdc No dim (1)	704005000002	100-240V	60W	84%	0.92	<3%	93x78x56 mm	296 gr	35A	
PSU DIN RAIL 100W 24Vdc No dim (1)	704105000002	100-240V	100W	89%	0.92	<3%	100x93x56 mm	342 gr	40A	

All values are measured at 230V (+/- 7%)

INCLUDING CONNECTION BOX

For installation to a central power supply.

