

REWARDING BRIGHTNESS



Downlights

Fluxe 35
Fixed

Specifications

Colour(s)	Matt white RAL9016 (XX=MW) / Matt black RAL 9005 (XX=BL) / Matt grey RAL 9006 (XX=GR)
Beam angle (FWHM)	40° (65° FWTM)
Fixture material	Housing: Die cast aluminium / Reflector glass: Polycarbonate
Environment	Indoor
IP rate	IP20 / IP44
IK rate	IK03
Operating temperature (Ta)	-20°C / +45°C
Safety marks	EN60598 / EN62031 / EN62471
EMC compliance	EN55015
Colour consistency (SDCM)	MacAdam step 3
Warranty	7 years

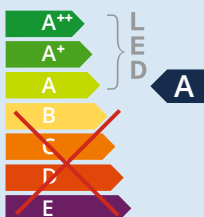

This luminaire contains built-in LED lamps

The lamps cannot be changed in the luminaire.

874/2012



Only for plasterboard ceilings or similar hard materials.

Only when the product is installed in a closed ceiling it may be exposed to water splashes, and only on its front side.

REWARDING BRIGHTNESS

Fluxe 35 (non-dimmable - incl. individual power supply)

100-240V

Downlight incl. PSU

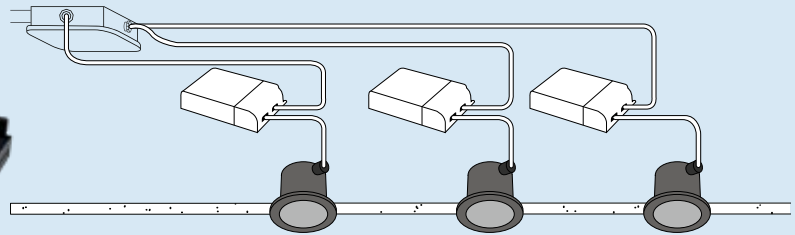
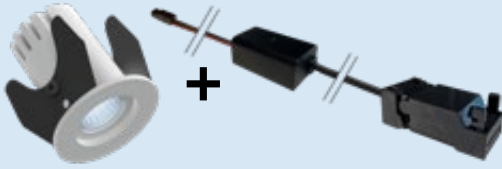

Item specifications (part A)

Description	Item code	Type	Input	W	Lm	Lm/W	CRI (typ.)	UGR	Pf	Ripple	Inrush current	B-16A Fuse
Fluxe 35 LV 375 Lm 2700K No dim	921903XX0113	Incl. PSU	100-240V	5,7	375	66	82	14.4	0.6	<3%	20A 170µS	50 pcs
Fluxe 35 LV 400 Lm 3000K No dim	921903XX7213	Incl. PSU	100-240V	5,7	400	70	82	14.4	0.6	<3%	20A 170µS	50 pcs
Fluxe 35 LV 425 Lm 4000K No dim	921903XX0213	Incl. PSU	100-240V	5,7	425	75	82	14.4	0.6	<3%	20A 170µS	50 pcs

Item specifications (part B)

Description	Safety class	Energy class	Weight	Dimensions single carton	Quantity per carton	Expected lifespan (25°C)		
						L70B50	L80B50	L90B50
Fluxe 35 LV 375 Lm 2700K No dim	II	A	172 gr	105x105x61 mm	42 pcs	259.260 hrs	156.636 hrs	65.836 hrs
Fluxe 35 LV 400 Lm 3000K No dim	II	A	172 gr	105x105x61 mm	42 pcs	259.260 hrs	156.636 hrs	65.836 hrs
Fluxe 35 LV 425 Lm 4000K No dim	II	A	172 gr	105x105x61 mm	42 pcs	259.260 hrs	156.636 hrs	65.836 hrs

All values are measured at 230V (+/- 7%).

Dimensions

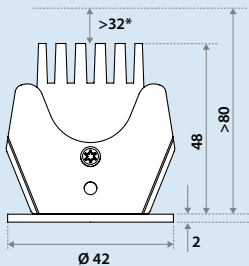

* This distance is necessary because of the height of the connection box (80 mm). For purely heat reasons just 5 mm is sufficient.

Incl. PSU No dim

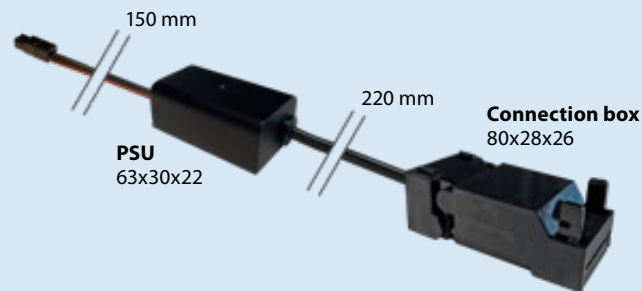

REWARDING BRIGHTNESS

Fluxe 35 (dimmable - excl. central power supply)

350 mA

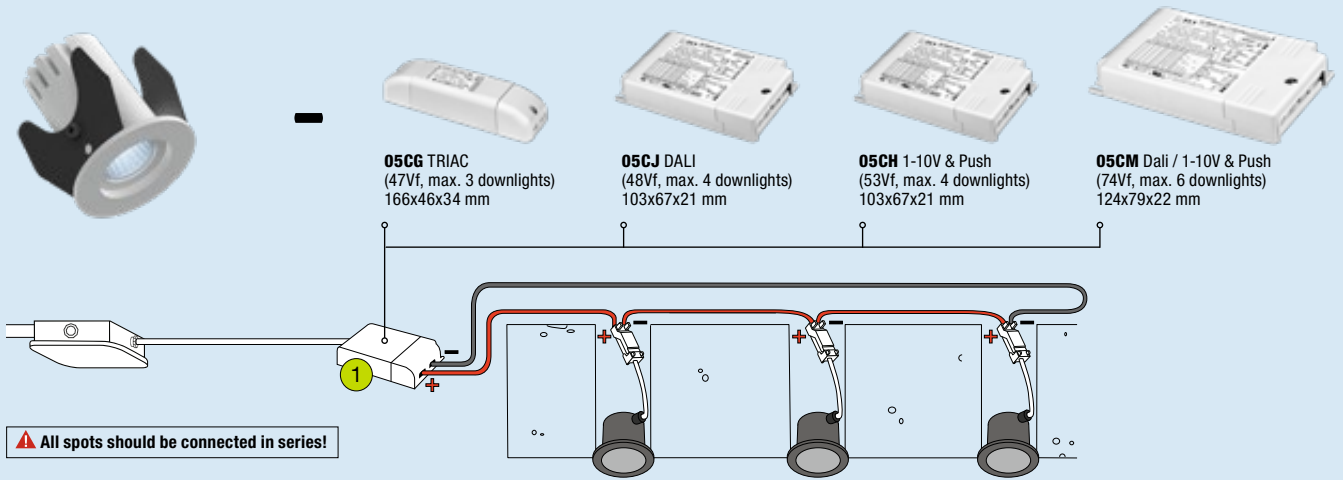

Item specifications (part A)

Description	Item code	Type	Input	Vf	W	Lm	Lm/W	CRI	UGR (typ.)	Pf	Ripple	Inrush current	B-16A Fuse
Fluxe 35 LV 350mA 375 Lm 2700K Dim	925303XX0111	Incl. Conn.Box	350mA	11,9	4,5	375	83	82	14.4	x	x	x	x
Fluxe 35 LV 350mA 400 Lm 3000K Dim	925303XX7211	Incl. Conn.Box	350mA	11,9	4,5	400	89	82	14.4	x	x	x	x
Fluxe 35 LV 350mA 425 Lm 4000K Dim	925303XX0211	Incl. Conn.Box	350mA	11,9	4,5	425	94	82	14.4	x	x	x	x

Item specifications (part B)

Description	Safety class	Energy class	Weight	Dimensions single carton	Quantity per carton	Expected lifespan (25°C)		
						L70B50	L80B50	L90B50
Fluxe 35 LV 350mA 375 Lm 2700K Dim	III	A	122 gr	105x105x61 mm	42 pcs	259.260 hrs	156.636 hrs	65.836 hrs
Fluxe 35 LV 350mA 400 Lm 3000K Dim	III	A	122 gr	105x105x61 mm	42 pcs	259.260 hrs	156.636 hrs	65.836 hrs
Fluxe 35 LV 350mA 425 Lm 4000K Dim	III	A	122 gr	105x105x61 mm	42 pcs	259.260 hrs	156.636 hrs	65.836 hrs

Dimmable central power supply

Description	Item code	Watt	Current	Efficiency	Pf	Ripple	Input	Weight	Inrush current	B-16A Fuse
PSU 32W 350mA Triac (1)	05CG03MLMD00	32W (47Vf)	350mA	85%	0.97	<3%	220-240V	138 gr	5A 50µS	50 pcs
PSU 32W 350mA Dali (1)	05CJ03MLMD00	32W (48Vf)	350mA	87%	0.98	<3%	220-240V	138 gr	5A 50µS	50 pcs
PSU 32W 350mA 1-10V & Push (1)	05CH03MLMD00	32W (53Vf)	350mA	90%	0.95	<3%	220-240V	138 gr	5A 50µS	50 pcs
PSU 50W 350mA Dali / 1-10V & Push (1)	05CM03MLMD00	50W (74Vf)	350mA	89%	0.95	<3%	220-240V	218 gr	20A 400µS	15 pcs

All values are measured at 230V (+/- 7%).

Dimensions

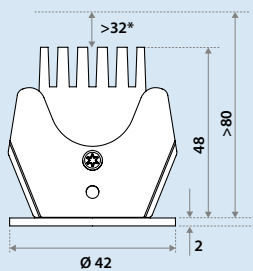

* This distance is necessary because of the height of the connection box (80 mm). For purely heat reasons just 5 mm is sufficient.

Including connection box

For installation to a central power supply.

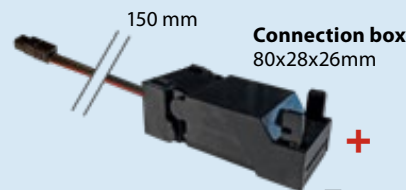

REWARDING BRIGHTNESS

Fluxe 35 (non-dimmable - excl. central power supply)

24Vdc

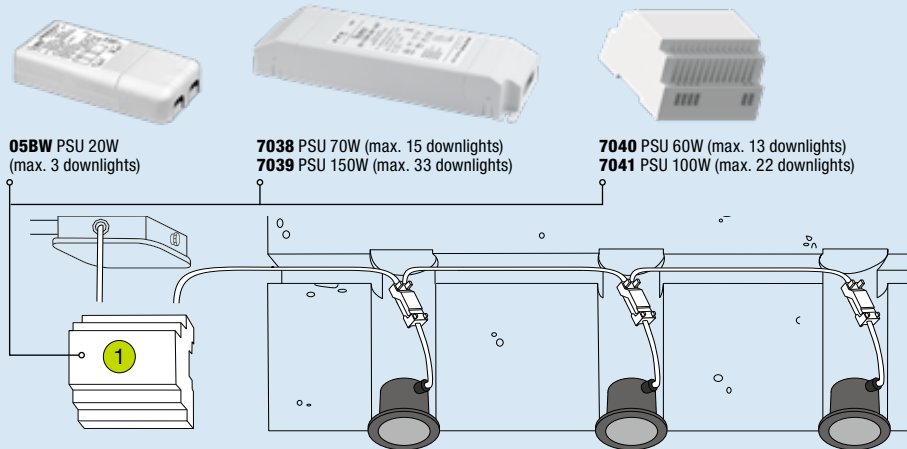

Easy installation, all spots can be connected in parallel!

Item specifications (part A)

Description	Item code	Type	Input	W	Lm	Lm/W	CRI (typ.)	UGR	Pf	Ripple	Inrush current	B-16A Fuse
Fluxe 35 LV 24Vdc 375 Lm 2700K No dim	921903XX0111	Incl. Conn.Box	24Vdc	4,5	375	83	82	14.4	x	x	x	x
Fluxe 35 LV 24Vdc 400 Lm 3000K No dim	921903XX7211	Incl. Conn.Box	24Vdc	4,5	400	89	82	14.4	x	x	x	x
Fluxe 35 LV 24Vdc 425 Lm 4000K No dim	921903XX0211	Incl. Conn.Box	24Vdc	4,5	425	94	82	14.4	x	x	x	x

Item specifications (part B)

Description	Safety class	Energy class	Weight	Dimensions single carton	Quantity per carton	Expected lifespan (25°C)		
						L70B50	L80B50	L90B50
Fluxe 35 LV 24Vdc 375 Lm 2700K No dim	III	A	122 gr	105x105x61 mm	42 pcs	259.260 hrs	156.636 hrs	65.836 hrs
Fluxe 35 LV 24Vdc 400 Lm 3000K No dim	III	A	122 gr	105x105x61 mm	42 pcs	259.260 hrs	156.636 hrs	65.836 hrs
Fluxe 35 LV 24Vdc 425 Lm 4000K No dim	III	A	122 gr	105x105x61 mm	42 pcs	259.260 hrs	156.636 hrs	65.836 hrs

Central power supply

Description	Item code	Input	Watt	Efficiency	Pf	Ripple	Dimensions	Weight	Inrush current	B-16A Fuse
PSU 20W 24Vdc No dim (1)	05BW03MLMC00	220-240V	20W	87%	0.93	<3%	111x52x22 mm	108 gr	5A 50µS	50 pcs
PSU 70W 24Vdc No dim (1)	703805000002	220-240V	70W	91%	0.97	<3%	225x60x36 mm	448 gr	15A 600µS	15 pcs
PSU 150W 24Vdc No dim (1)	703905000002	220-240V	150W	94%	0.98	<3%	240x60x49 mm	582 gr	35A 1000µS	8 pcs
PSU 60W 24Vdc No dim (1)	704005000002	100-240V	60W	84%	0.92	<3%	93x78x56 mm	296 gr	35A	
PSU 100W 24Vdc No dim (1)	704105000002	100-240V	100W	89%	0.92	<3%	100x93x56 mm	342 gr	40A	

All values are measured at 230V (+/- 7%).

Dimensions

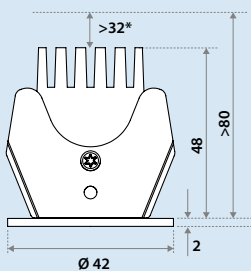

* This distance is necessary because of the height of the connection box (80 mm). For purely heat reasons just 5 mm is sufficient.

Including connection box

For installation to a central power supply.

